

# CLIP top inset blind corner hinges

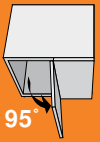

CLIP top/CLIP



## Features

- 95° opening angle
- 3-dimensional adjustment
- All metal hinge, nickel plated
- Available with INSERTA tool-free attachment

Cover caps  
Mounting plates

page 31  
pages 47-52

## Minimum Reveal

| Minimum reveal table |     |     |     |     |     |      |
|----------------------|-----|-----|-----|-----|-----|------|
| 0.1                  | 0.3 | 0.4 | 0.5 | 0.9 | 1.3 | 3    |
| 0.1                  | 0.3 | 0.4 | 0.5 | 0.9 | 1.3 | 4    |
| 0.1                  | 0.4 | 0.4 | 0.5 | 0.9 | 1.3 | 5    |
| 0.1                  | 0.3 | 0.4 | 0.5 | 0.9 | 1.2 | 6    |
| 0.1                  | 0.3 | 0.4 | 0.5 | 0.9 | 1.2 | 7    |
| 16                   | 18  | 19  | 20  | 22  | 24  | B    |
| T Door thickness     |     |     |     |     |     | Bore |

Cross-reference the door thickness and bore distance to assure that doors won't bind when opened.

See back cover fold out for more specifications →

## Flush door applications

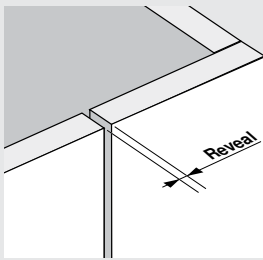

Back of door is flush with stationary panel

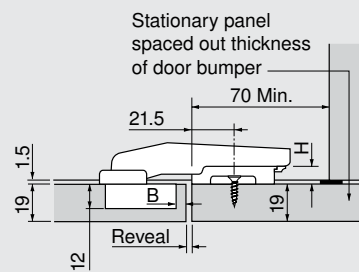

## Inset blind corner hinges

|  | Self close |
|--|------------|
| Screw-on   | 79T9550    |
| Press-in  | 79T9580    |
| INSERTA  | 79T9590B   |

| Reveal table |                 |   |   |   |   |            |    |
|--------------|-----------------|---|---|---|---|------------|----|
| 3            | 5               | 4 | 3 | 2 | 1 | 33.5       | 21 |
| H            | 3               | 4 | 5 | 6 | 7 | P          | S  |
| Plate        | B Bore distance |   |   |   |   | Clearances |    |

## Offset door applications

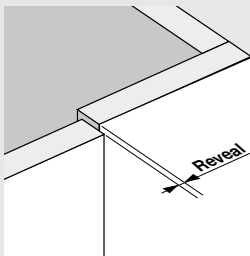

Stationary panel mounted to cabinet side, top and bottom

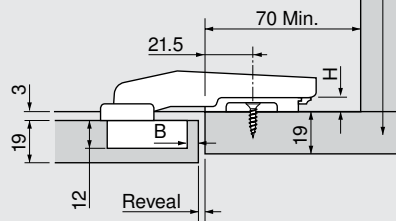

## Inset blind corner hinges

|  | Self close |
|--|------------|
| Screw-on   | 79T9550    |
| Press-in  | 79T9580    |
| INSERTA  | 79T9590B   |

| Reveal table |                 |   |   |   |   |            |    |
|--------------|-----------------|---|---|---|---|------------|----|
| 0            | 5               | 4 | 3 | 2 | 1 | 33.5       | 18 |
| H            | 3               | 4 | 5 | 6 | 7 | P          | S  |
| Plate        | B Bore distance |   |   |   |   | Clearances |    |

## Adjustments and clearances

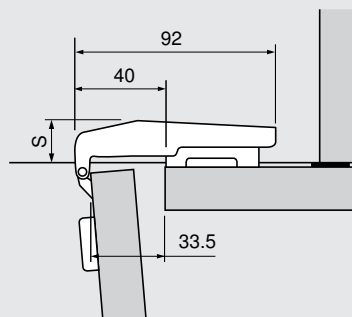

For more information on using this section see page 5.

All dimensions in millimeters.

Subject to technical modifications without notice. © 2007